

DFA1101GZ5AD6J-907

Light Commercial Truck

Operation Manual

DONGFENG AUTOMOBILE CO., LTD.

2006, 05

Foreword

Thank you for purchasing the DFA1101GZ5AD6J-907 light commercial truck that manufactured by DONGFENG AUTOMOBILE CO., LTD of the People's Republic of China.

This manual contains necessary procedures and instructions for the operation, inspection and maintenance for your DFA1101GZ5AD6J-907 truck.

This vehicle is equipped with the EQB140-20 DONGFENG Cummins diesel engine which could reach the European II displacement standard.

To obtain the optimum performance from your new vehicle is the common goal for all of us, and it depends largely on your care and familiarity of the operation and maintenance of the vehicles. We sincerely hope that you read this manual thoroughly, and make sure that you are familiar with the operation and maintenance before you using the new truck.

The manual is a part of your vehicle. Please keep it with your truck. The information and figures in this manual are correct when publishing. Due to continuous improvement on our vehicles, maybe there are some instructions in the manual that does not accord with the actual vehicles. Please inquire when you get some problem.

The Application Section of Testing Department, Commercial product R&D Institute of DONGFENG AUTOMOBILE CO., LTD. is in charge of compiling this manual. DFAC reserve the right to make changes at any time without notice.

As for vehicle saling, maintaining or spare parts purchasing, please consult with the local agency.

The manual uses the legal unit.

DONGFENG AUTOMOBILE CO., LTD.
2006. 05

Truck Nameplate

Truck Nameplate Position

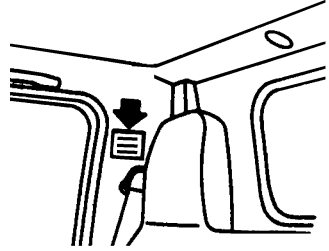

Engine Nameplate Position

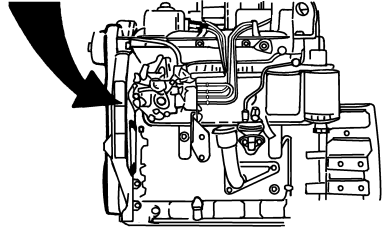

VIN Position

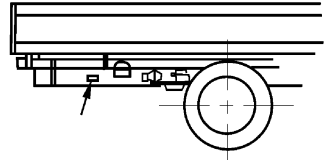

Table of Content

Truck Nameplate 1-1

Truck Nameplate Position 1-1

Engine Nameplate Position..... 1-1

VIN Position 1-1

Main Technical Specifications 2-1

Main Technical Specifications and Structure Features 2-1

Operational Data 2-2

Engine Parameter..... 2-2

Chassis Type and Structure Parameter 2-3

Construction and Operation 3-1

Arrangement of the Cab 3-1

Doors 3-2

Seats 3-3

Instruments..... 3-4

Indicators 3-6

Keys..... 3-9

Key Switch 3-9

Light Combination Switch..... 3-10

Power Switch..... 3-13

Exhaust Brake Switch..... 3-13

Air Horn and Electric Horn Shift Switch 3-14

Air Drier Switch 3-14

Dome Lamp and Glove Box 3-14

Cab Skylight 3-15

Air Conditioning System 3-15

Levers, Steering Wheel and Accessories 3-16

Tilting Cab..... 3-21

Vehicle Starting 4-1

Engine Starting..... 4-1

Engine Starting (when the cab is tilted) 4-2

Running-in and Maintenance of New Vehicle	5-1
Before Running-in	5-1
Running-in Period	5-2
After Running-in	5-2
 Driving Recommendations	6-1
Driving on a slope	6-2
Clutch Operation	6-2
Double-foot-clutch Method for Shifting	6-3
The Use of Warning Triangle	6-3
Parking	6-4
 Vehicle Inspection	7-1
Driver's Daily Inspection	7-1
Vehicle External Inspection	7-2
 General Maintenance	8-1
Air Filter	8-1
Diesel Oil Prefilter	8-2
Fuel Filter and Fuel-water Separator	8-2
Oil Filter	8-2
Fuel Tank Draining	8-3
Fuel Pump	8-3
Exhaust Gas Turbo Supercharger	8-4
Air Drier	8-6
Check the Oil Level, and Refill the Clutch Oil Reservoir	8-6
The Transmission Lubricating Oil	8-6
The Rear Axle Main Reductor Lubricating Oil	8-7
Power Steering Lubricating Oil	8-8
Battery Checking and Maintenance	8-9
Fuse	8-10
Suspension	8-10
Tire Rotation	8-11
Clean and Replace the Wiper Blades	8-12
 General Adjustment.....	9-1

Using Engine in a Environmental Protection Standard	9-1
Drain Water Out from the Cooling System	9-2
Check the Opening Temperature of the Thermostat	9-2
Adjustment of Fan Belt	9-3
Pump Fuel Manually and Bleed Air Out of Fuel Supply System	
9-4 Water-leak Hole of the Water Pump	9-4
Air Valve Clearance Adjustment	9-4
Adjustment of Clutch	9-5
Air Release of Clutch	9-6
Adjustment of Brake Clearance	9-7
Brake system	9-9
Adjustment of wheel hub bearing	9-9
Adjustment for the front wheel hub bearing	9-10
Adjustment for the front wheel hub bearing	9-10
Adjustment of Free Play of Steering Wheel	9-10
Adjustment for Toe-in	9-11
Maintenance Schedule	10-1
Engine	10-1
Clutch	10-2
Transmission	10-3
Brake System	10-3
Steering System	10-4
Suspension System	10-5
Propeller Shaft	10-5
Axle and Wheel	10-6
Others	10-6
Main Adjusting Data	10-7
Fuel	10-8
Grease Application Place and Schedule	10-8
Lubricant and Vehicle Used Fluid	10-9
Engine Lubricant	10-10
Gear Oil	10-11
Transmission Gear Oil	10-11
Lubricating Grease	10-11
Shock Absorber Oil	10-11

Clutch Boost Liquid	10-11
Engine Anti-freeze Fluid (cooling fluid)	10-11
Capacity Data	10-12
Tightening Torque	11-1
Engine	11-1
Chassis	11-2
Attached Drawing	12-1
Electric System Drawings	12-1

Main Technical Specifications

Main Technical Specifications and Structure Features

● General Data

Vehicle Model		DFA1101GZ5AD6J-907	
Rated Loading Weight (kg)		4990	
Curb Weight (kg)		4420	
Gross Weight (kg)		9605	
Load Distribution (kg)	Front axle	No-load	2235
		Full-load	3195
	Rear axle	No-load	2185
		Full-load	6410
Overall Dimension (mm)		Length	8350
		Width	2330
		Height (no-load, to cab top)	2395
Wheel Base (mm)		4700	
Wheel Tread (mm)	Front wheel	1831	
	Rear wheel	1640	
Front/Rear Overhang (mm)		1270/2380	
Approach angle/Departure angle		25.5° / 11°	
Min. Ground Clearance (mm) (Full-load)		240	
Min. Turning Diameters (m)		19	
Structure Features		Cab over engine, single row, equipped with EQB140-20 engine	

Operational Data

Max speed (km/h)	105
Max gradability (Full-load on dry and hard road, the slope length is over 15m)	$\geq 30\%$
Ability of parking on the slope	$\geq 20\%$
100km fuel consumption (L)	≤ 13
Max continuous running distance (km)	500
Fuel type	RC-0#(summer), RC-10#(winter) vehicle used light diesel oil

Engine Parameter

Model	EQB140-20
Type	4 in-line cylinders, supercharging and intercooling, direct injecting DONGFENG Cummins diesel engine, reach the European II displacement standard
Bore \times Stroke (mm \times mm)	102 \times 120
Displacement (L)	3.92
Compression ratio	17.3:1
Rated power (kW/rpm)	103/2700
Rated torque (N.m/r/min)	502/1500
Min. specific fuel consumption (g/kW.h)	210
Injecting order	1-3-4-2

Main Technical Specifications

Single tyre on the front axle, double tyre on the rear tyre, and a spare tyre on the spare tyre carrier hang under the rear end of the frame.

Tyre: 8.25-20

Tyre inflating pressure:

Front wheel is 490kPa and rear wheel is 560kPa, while the allowable inflating pressure is 630kPa.

8. Steering system

Circulating ball type with power steering.

Max front wheel turning angle (inside/outside): 40° / 32°

9. Brake system

Service brake: dual-circuit, air brake system, and front and rear brake are self-adjustable, cam, air-operated, drum brake with the exhaust auxiliary brake system.

Parking brake: spring brake controlled by manual-operated valve through air pipes.

10. Frame

Ladder type, longitudinal is grooving section and riveted by several crossbeams, part of the frame has stiffening plate.

11. Electric equipment and instruments

Single, negative earthed line, 24V.

Battery: 6-QW-90DF

Starter: 24V, 3.7kW

Alternator: 45A, 28V

Main switches:

Power switch, combined switch, ignition switch, assistant starting switch, heater switch, etc.

Instruments:

Speedometer and odometer, water temperature gauge, fuel gauge, air-pressure gauge, oil pressure gauge, etc.

Indicators:

Water temperature indicator, oil pressure indicator, fuel level warning indicator, oil pressure warning indicator, turning signal indicator,

charge warning indicator, parking indicator, water overheat or level over low warning indicator, reversing warning indicator, electric horn, etc.

Lamps:

Head lamp, front combined lamp, fog lamp, turning signal lamp, license lamp, tail combined lamp, front clearance lamp, rear clearance lamp, side marker lamp, etc.

12.Cab

New developed, all metal structure, tilting, wide cab with single row and a sleeper. Interior trimming has two types: standard and luxury. The driver's seat can be adjusted for ward and backward. The driver and the assistant's seats are fitted with 3 point-seat belt, the middle seat is fitted with 2 point-seat belt. The cab is equipped with full-scope windshield, sun shield, inner rear view mirror, and radio cassette, etc.

13.Tools equipment

Every commercial vehicle is equipped with a set of tools.

Construction and Operation

Arrangement of the Cab

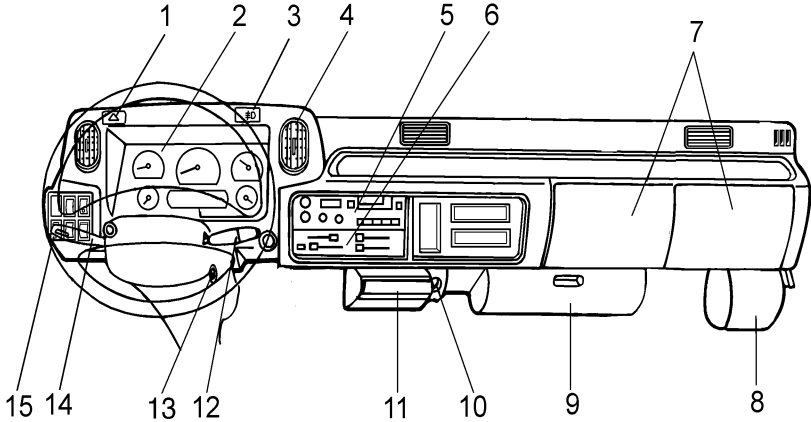

- | | |
|--------------------------------------|---|
| 1. Hazard warning lamp switch | 9. Fuse box |
| 2. Instrument panel | 10. Cigarette lighter |
| 3. Front fog lamp switch | 11. Ashtray |
| 4. Wind channel | 12. Windshield wiper and washer controlling rod |
| 5. Radio cassette | 13. Ignition lock |
| 6. Heater and air-conditioner switch | 14. Combined light switch |
| 7. Glove box | 15. Combination switch |
| 8. Windshield washer fluid reservoir | |

Doors

- Opening doors
From the outside

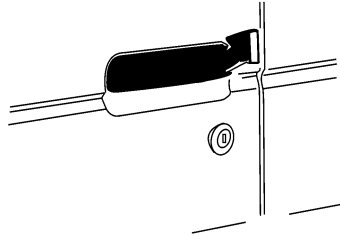

From the inside

Note:

After closing the door, please double check whether the door is really closed. Driving with the door half closed can be very dangerous.

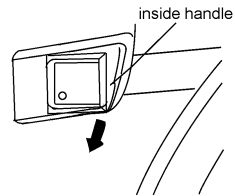

- Closing doors
From the outside

Turn the key forward to lock the door, while turn it backward to unlock the door.

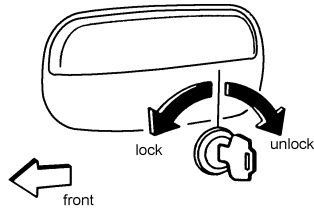

From the inside

Set the lock ball to the locked place, and pull the door handle to close the door.

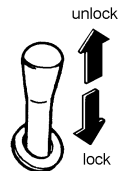

Seats

- Driver's seat forward and backward adjustment

Raise the adjusting lever on the front side of the seat, and move the seat forward and backward till to the optimum, then release the adjusting lever and lock the seat in the desired position.



- Driver's seat back angle adjustment

Raise the adjusting lever on the left side of the seat, and adjust the seat back to an angle most appropriate for holding the steering wheel, then release the lever to lock the seatback in the desired position.

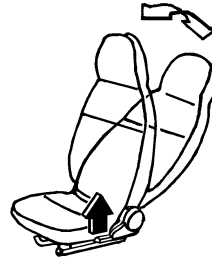

- Assistant's seat back adjustment

Turn the knob located on the right side of the seat, the seatback will be adjusted to the desired position or putted down face to the seat.

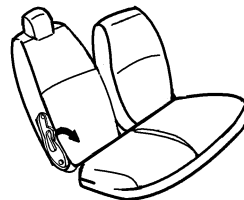

● Center seat back adjustment

Turn the knob located on the left side of the seat, the seatback will be adjusted to the desired position or putted down face to the seat.

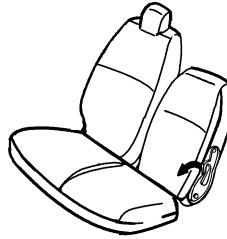

● Safety belts

Slowly pull out the safety belt and make it throught your body from the left side of your neck to the right side of your waist and press the button, then insert the locking hook into the latch hook. Adjust the length of the safty belt to the optimum.

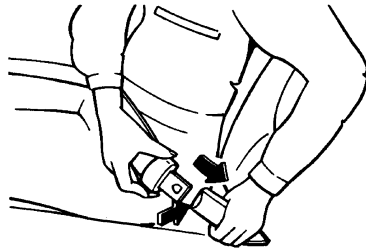

Note:

Adjust the position of the seat correctly;

Make sure that the safty belt is not winded or rubbed by hard edge, and far away from the chemical and battery acid;

One belt for one person;

After being overused, invalid or damaged, the whole belt should be changed;

If the safty belt retractor does not work well, the whole belt should be changed immediately.

Instruments

1. Fuel Gauge

The fuel gauge use to indicate the approximate level of fuel remaining in the fue tank. The needle will change because of vehicle braking, turning, accelerating or climbing.

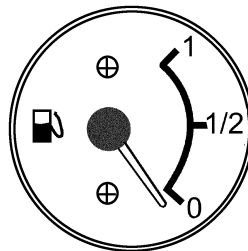

Note:

Do remember refill the fuel tank with clean fuel before the gauge indicates that the fuel has been used up.

2. Water Temperature Gauge

The gauge indicates the engine water temperature. Its needle will change because of atmospheric temperature and driving condition.

Note:

Be sure to stop the vehicle as soon as possible when the needle of the gauge beyond the normal range. To run the vehicle with an overheated engine is extremely harmful to the engine.

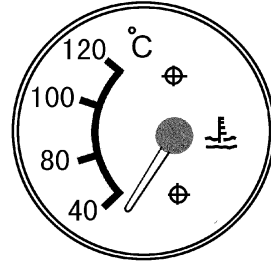

3. Tachometer

The needle of the tachometer indicates the engine speed in revolutions per minute. The red zone indicates a range of critical engine speed. Be sure to always keep the indicator below this critical zone. The green zone indicates the range for the most economical engine operation. Driving under this green zone will save fuel and extend the service life of the engine.

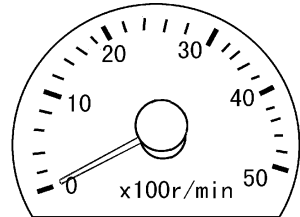

4. Speedometer

The speedometer indicates the speed of the vehicle in kilometers per hour. The odometer indicates the accumulated driving distance in kilometers.

The trip meter is used to represent the running distance of a day or a trip. Do remember to press the reset button to delete the numbers before

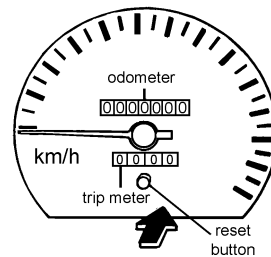

you use it. The most right number has a unit of 0.1km.

Note:

Do not press the reset button during the driving period.

Do not pull or turn the reset button when press it.

5. Air-pressure Gauge

There are two gauges here, one for front brake system, the other for rear brake system. The range of the indicator is from 0~12x100kPa, while 0~4x100kPa is in red zone, and under that condition the vehicle cannot be started. Only when the indications of the two needles all over 4x100kPa can the vehicle be started.

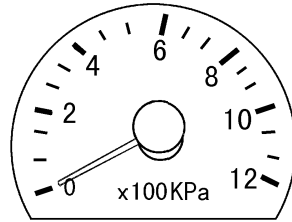

Indicators



taillamp warning indicator



parking brake warning indicator



oil pressure warning indicator



exhaust brake indicator



safety belt indicator



brake down warning indicator



high beam indicator



fuel warning indicator



air-filter block warning indicator



charge warning indicator



rear fog indicator



turning signal indicator



fuel-water separator indicator



water temperature warning indicator

1. Taillamp Warning Indicator

The indicator will lighten when any of the taillamp (exclude the turning lamp) is in trouble.

2.Exhaust Brake Indicator

The indicator will light when the exhaust brake is switched on.

3.High Beam Indicator

The indicator will light when the high beam is used, and if the passing light is used, the indicator will also light.

4.Charge Warning Indicator

The light will light when the key switch is turned on, and will extinguish when the engine is started and charging is initiated. If charging is stopped due to the failure of the charging system during engine operation, the light will light.

Note:

Never run the vehicle with the warning light on. This will run down the battery.

5.Fuel-water Separator Indicator

If the sensor of the fuel-water separator indicates that the water level is too high, this indicator will light and remind the driver to drain water.

6.Parking Brake Warning Indicator

The light will light when the parking brake is actuated to aware the driver that the vehicle is in the braking condition. The light will extinguish when the parking brake stops operating. Before moving the vehicle, make sure the light is off.

7.Safety Belt Indicator

The indicator will flash for 7 seconds to aware the driver and

passengers to use the safety belts when the ignition lock is placed at "ON" position.

8. Fuel Warning Indicator

The indicator will light when the remaining fuel is too little to assure the normal driving. It is used to aware the driver to refill the tank.

9. Rear Fog Indicator

The light will light when the rear fog lamp is used.

10. Water Temperature Warning Indicator

The light will light when the temperature of the water is over 101 °C . At the same time, a buzzer will sound to make the driver aware that the engine is in dangerous situation. The buzzer stops when the key switch is turned off with the engine stopped.

11. Oil Pressure Warning Indicator

The light will light when the key switch is turned on, and will extinguish after the engine starts. It will be lighted again when the oil pressure is too low during the operation of the engine.

Note:

The low pressure of the engine will cause the damage of the engine.

Never run the vehicle with the warning light on.

12. Brake-down Warning Indicator

The light will light when the level of the brake fluid drops or the front

brake lining is worn out. Do remember to refill with brake fluid or change the brake lining.

13. Air Filter Block Warning Indicator

When the air filter is blocked, the indicator will light up to remind the driver to clean it.

14. Turning Signal Indicator

This indicator is used to indicate the working condition of the turning signal lamp. Switch on it and both the left and right indicator are flashing.

Keys

There are two keys provided that used to start the vehicle, open or lock the door.

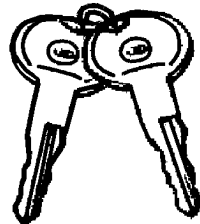

Key Switch

LOCK: Only the key is set on the LOCK position can it be inserted or pull out.

OFF: Turn the key from ON to OFF to shut-down the engine.

ACC: Set the key at the ACC position to use any of the accessories (such as radio cassette, wiper, cigarette lighter, etc), while the engine is not operating.

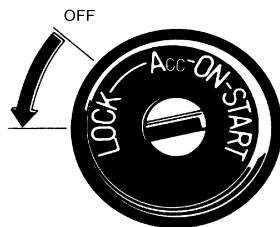

ON: After the engine starting, the key return from START to ON and the engine is started normally. Never turn the key to any other position while the engine is running.

START: Set the key to the START position to start the engine. The key will return automatically to the ON position when released from the START position.

Note:

Never turn the key to the START position while the engine is running, or else it makes the starter damaged. Only after the engine stops can the engine be started again.

Light Combination Switch

This combined switch is used for front lamp, tail lamp, head lamp, instrument lamp, licence lamp, passing lamp, dimmer and turning lamp, etc.

1.Light switch

Turn the end knob of the combination switch lever forward, the lamps represented in the below chart will illuminate depending on the position of the switch.

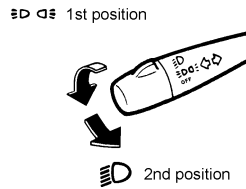

○ ON xOFF

Knob position	Head lamp	Front lamp	Tail lamp	Licence lamp	Instru ment lamp	Front clearan ce lamp	Rear clearance lamp	Side clearance marker
OFF	x	x	x	x	x	x	x	x
1st position	x	○	○	○	○	○	○	○
2nd position	○	○	○	○	○	○	○	○

2. Turn signal light switch

Put the control lever forward and backward to make the left or right turn signal lamp blinked.

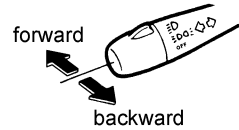

3. Dimmer switch

Put the combined switch control lever up and down to change from the high beam to low beam or from the low beam to high beam. If there is a coming vehicle, do remember to use it.

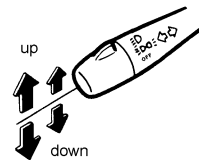

4. Passing light switch

The head light high beam will lighten as long as the lever is being pulled from the low beam position, and when releasing the lever, it will automatically return back to the low beam position. You can use this to tell front vehicles that you're going to pass them. During the normal running condition of the vehicle, no matter other lights' condition, if you use the passing light, it will be on.

5. Windshield Wiper and Washer Switch

When the front windshield is dirty and needs to wash, press the button on top of the windshield washer lever, the washer will operate and the washer fluid will be sprayed out continuously. At the same time, the equipped intermitted wiper (3-speedtype) is also

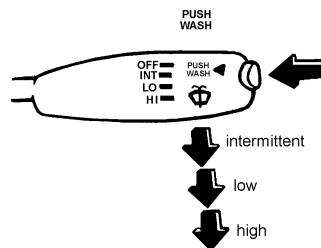

operating. The wiper should be moved two or three more times after the washer stops. The wiper starts after pulling the lever backward. It has intermittent, low and high three speeds. Release the button, the washer stops. Pull the lever to the end of the front, the wiper stops.

Note:

Use of the wiper alone will scratch the windshield. Be sure to operate it with the washer when the weather is well.

Do not use the washer without washer fluid, otherwise the washer motor will be damage.

6.Hazard Warning Indicator Switch

Use this switch to warn other drivers when your vehicle becomes a traffic hazard source due to mechanical trouble. If switch on it, all left and right turning signal lights are lightened, and the turning signal indicator will flash simultaneously.

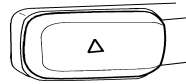

7.Front Fog Lamp Switch

When this switch is pushed, the fog lamps, front lamps and tail lamps all come on. Use this switch to control the lights when driving in a thick fog.

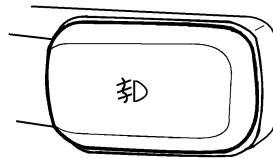

8.Rear Fog Lamp Switch

In the condition that the front fog light is on, switch on this and the rear fog lights come on, while switch off, the rear fog lights will be off.

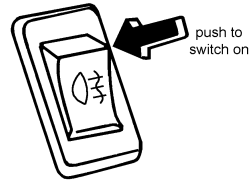

Power Switch

The rocker switch is used to control the electromagnetic power switch in the circuit system. Set the switch to the ON position to turn-on the vehicle circuit system, and set it to the OFF position to cut-off the circuit system. The circuit should be switched off to protect other electrical equipments in case the circuit system is checked or repaired.

Note:

Don't turn off the power switch when the engine is running.

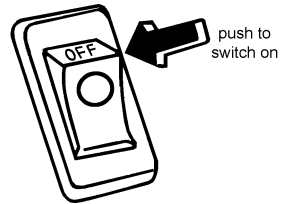

Exhaust Brake Switch

It is used to control the exhaust brake.

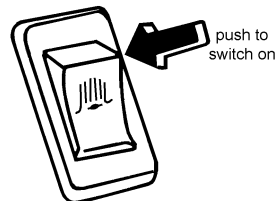

Air Horn and Electric Horn Shift Switch

Choose the air horn or electric horn as you need.



Air Drier Switch

During raining or snowing days, switch on the air drier to dry the air in the brake system to assure the vehicle brake performance.

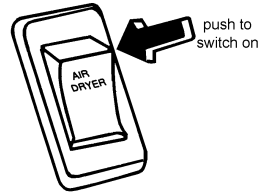

Dome Lamp and Glove Box

There are one glove box and two lamps on the inner front of the cab. If you want to use the glove box, just pull down the lid.

As for two dome lamps, press the left button they will lighten no matter the door is open or not; press the right button they will lighten if any of the door is opened.

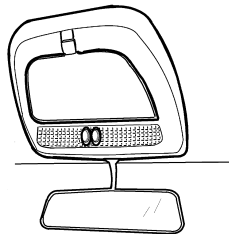
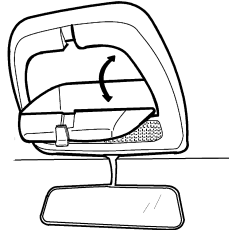

Cab Skylight

When you want to introduce some fresh air into the cab, just push up the switch of the skylight.

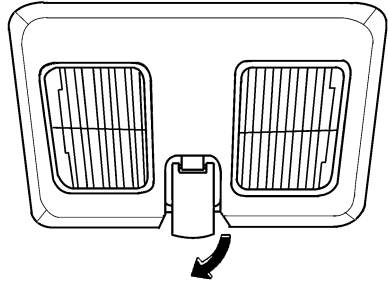

Air Conditioning System

1. Ventilator

Turn the central roller to change the direction of the airflow.

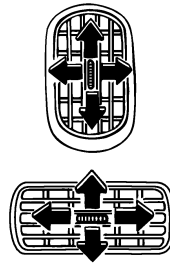

2. Air-conditioner

Air-conditioner switch

When the air-conditioner is needed, press this switch and the indicator light goes on which means the connection of power supply.

Fan switch

There are five speeds provided, from 0 to 4. At 0 position, the fan stops, and the wind will become even stronger from 1 to 4 speed successively.

Temperature slide switch

It is used to adjust the inside temperature. Move the slide switch from left to right and the temperature will be adjusted from low to high.

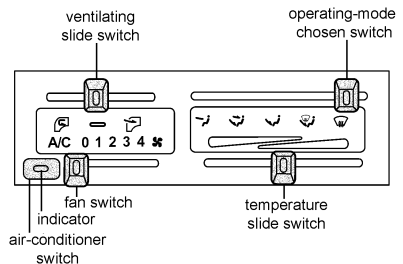

Ventilating slide switch

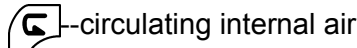

Operating-mode chosen switch

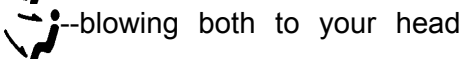
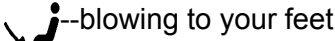
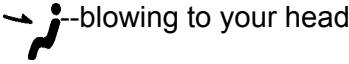

and feet

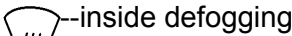

Note:

The warm air is heated by the cooling liquid of the engine. Its temperature depends on the temperature of the cooling liquid.

Please do not use the heating device too long when the engine is stop or idle, otherwise it will wear out the battery and influence the normal driving.

Do not forget to reduce the transmission speed and raise the engine revolution during low speed running, or climbing the long slope, to reduce the engine load.

You have to wait for 2-3 minutes before you restart the air-conditioner to extend the service life of the compressor.

You also have to operate the air-conditioner for 10 or more minutes every month even in winter to extend its service life.

Levers, Steering Wheel and Accessories

1. Transmission gear shift lever

When shifting gears, be sure to fully trample down the clutch pedal.

EQ1074T5AD-666

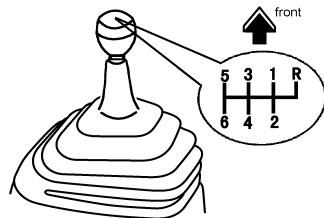

Before shifting the gears from forward to reverse or from reverse to forward, be sure to make the vehicle stopped at first.

When the gear shift lever is set at the "R"(reverse) position, the reverse lamp will go on, and the reverse buzzer will sound simultaneously to alarm the passers-by and vehicles.

2.Parking brake knob

Pull up the parking brake knob backward after the vehicle stopped to lock the vehicle. To release the parking brake, first pull up the lock sleeve of the knob, then push the knob forward.(if the air pressure is too low, the parking brake cannot be released)

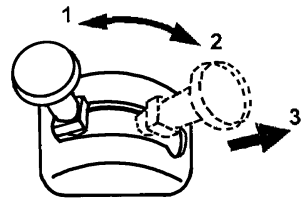

1. Push forward to release
2. push backward to brake
3. Pull up a little

3.Steering wheel adjustment

Loosen the lock knob, and the steering wheel can be tilted forward and backward, upward and downward. Before adjust the steering wheel, first adjust the seat to suit the driver's build. After that, be sure to tighten the lock securely to prevent the steering wheel from being accidentally moved while the vehicle is in driving state.

Note:

The adjustment of the steering wheel must be performed only when the vehicle is parking. Adjustment of the steering wheel while driving is strictly prohibited.

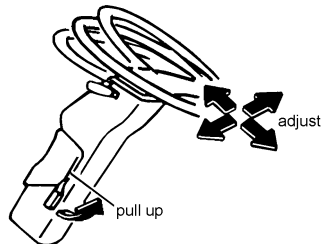

4. Rearview mirror and bottom view mirror adjustment

They can be adjusted to any direction to reach the optimum. Do not change the direction of the mirror during driving period, it will cause a traffic dangerous.

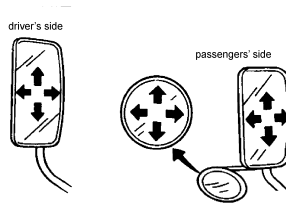

5. Cigarette lighter

Press down the cigarette lighter knob fully, then wait for ten seconds until the top end of the lighter becomes red hot before the lighter jump back to its original position automatically. Then it can be pulled out to use, and put back the lighter after lighting cigarettes

Note:

If the lighter cannot jump back automatically after pressing approx 10 seconds, please pull out it manually to avoid other troubles.

Be sure to use this cigarette lighter carefully. Careless or incorrect handling of it may cause a fire accident.

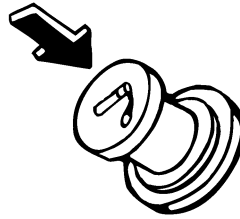

6. Ash tray

Pull out the ash tray to use it. Detach the tray for cleaning by pressing down the ash tray tongue while pulling the ash tray out.

Note:

Be sure to close the ash tray for a safety precaution.

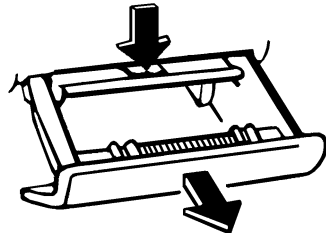

7. Radio cassette

Receive operation

Press down the PWR and then the TUNING to select the programs and broadcasting stations.

Use the volume knob to control the volume.

Use the RD to shift AM to PM broadcasting stations.

Tape play

Set the open end of the tape to the right side and it plays automatically, because the radio cassette will change from receiving status to playing status.

Press the BAL, and then can adjust the volume, tone, and balance to achieve the optimum sound effect.

Press the fast-forward (fast-forward) switch to choose the working status, and press again to release, then the tape is playing.

The tape will change its direction automatically until switch off.

Press the outlet button to stop it and then set the tape out.

Time

Press the F/C (time/wave band shift) to show time on the screen.

Press the SET to adjust time through MIN and HOR.

Note:

Press forcibly will set the tape out.

Press the outlet button to the end to stop and set the tape out.

Before switch on the radio cassette, you should not place a tape in it, and otherwise it will damage the tape or cause any other troubles.

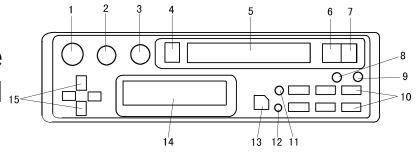

1. Tuning switch
2. Balance switch
3. Volume control switch
4. Outlet switch
5. Tape outlet
6. Fast backward switch
7. Fastforward switch
8. Tape/radio shift switch
9. Power switch
10. Indicator
11. Button to adjust the hour
12. Button to adjust the minute
13. Time set button
14. Display
15. Mode condition choose switch

If the volume obviously becomes low, the magnetic head needs to wash. Please use the special wash tape or tampon with alcohol or magnetic head cleanser to wash the magnetic head and the parts with surface contacting to the tape.

If the fuse is burnt, replace with a new one and find out the reason.

16. Spare tyre

The spare tyre is set underneath the chassis frame tail, hanged with its carrier. The operational schedule is as follows:

Use a spanner to turn the propeller lever at the counter clockwise direction to down the spare tyre. After that, take out the spare tyre from the holder and you can use it.

To install the spare tyre is to follow the contrary sequence.

Note:

The spare tyre should be installed firmly and avoid missing.

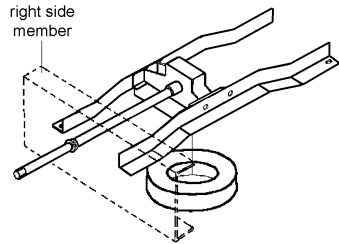

17. Expansion tank

The expansion tank is used to check whether the cooling system is short of cooling liquid or not. Open the expansion tank and fill with cooling liquid till overflow.

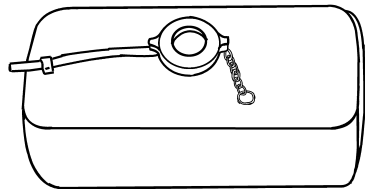

18. Glass regulator

Turn the knob at the clockwise direction lift the glass, and at counter clockwise direction to descend the glass.

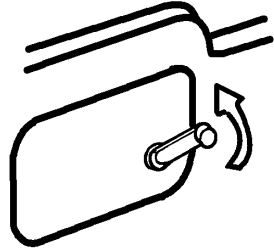

19. Quarter window

There are left and right quarter windows on a cab with sleeper, which used to ventilate.

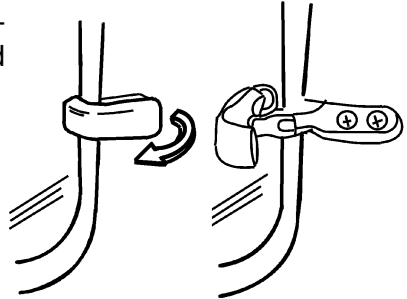

Tilting Cab

1. Precautions before Tilting Cab

Park the vehicle on a plain ground as possible as you can.

Note enough clearance between the roof height and the front wall when tilting the cab in a room.

Make sure whether the brake parking is in braking state or not. Set the gear shift lever on the neutral position.

Please withstand on every tyre with triangle chock if you need.

Be sure to take care of the objects in the cab during tilting the cab.

2. Tilt Operating

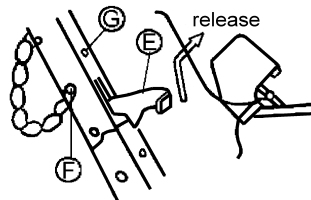
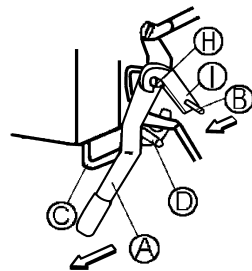

First push A with your left hand and pull B at the indicated direction with your right hand at the same time to release H from the hook, then pull up A to the limit.

After that, hold C with your left hand and pull D with your right hand until D release from J, then tilt the cab.

Be sure that E is hooked and pull out the safty pin from G and insert it into F at last.

3.Lock Operating

First hold C with your left hand to hold the cab, and pull out the safty pin from F, then insert it into G, and release E with your right hand at the same time.

After that, hold C to down the cab slowly until D hooks J. Please do not move A with your hand during operating and pay much attention to the falling cab and A.

At last, push down A until it hooks I completely.

Note:

When tilting the cab, starting engine and shift gear iare forbidden.

Vehicle Starting

Engine Starting

1. Check the oil and coolant level.
2. Check the fuel level.
3. Without the air-filter, the engine is forbidden to operate.
4. First using of a new vehicle and stopping for a long time, it has to use the hand priming lever of the fuel pump to pump fuel to bleed the air in the fuel system.
5. Make sure that the transmission gear shift lever is on the neutral position.
6. Turn the key switch to "ON" position, and check every warning indicator lamp to see whether is on or not.
7. Depress the accelerator to middle speed position and clutch pedal fully, and turn the key switch to the "START" position to start the engine.
8. After the engine has been started, release the key, and gradually release the accelerator pedal till idle running. Be sure to inspect the oil pressure within 15 seconds.

Note:

Don't keep the key in the "START" position for more than 5 seconds at a time, because continuously use of the start will cause the battery run down. If the engine fails to start, wait 20 seconds before trying again.

Vehicle Starting

The time for idling speed is no more than 5 minutes.

To ensure safety and reduce the motor load, please fully depress the clutch pedal when starting the engine.

Engine Starting (when the cab is tilted)

Pull up the parking brake lever and fill in the wheel with triangle chock.

Turn the key to "ON" position.

Be sure the transmission gear shift lever is set on the neutral position. The engine can't be started if the lever is on the other speed position.

Engine will be started when pressing the starter button.

Turn the key from "ON" position to "OFF", when stopping the engine running.

Note:

Don't keep the key in the "START" position for more than 5 seconds of one time. Otherwise it will be shorten the life of the battery.

If the engine fails to start, wait 20 seconds before trying again.

Don't touch the transmission lever when the cab is tilted during running.

Don't put down the cab when the engine is running.

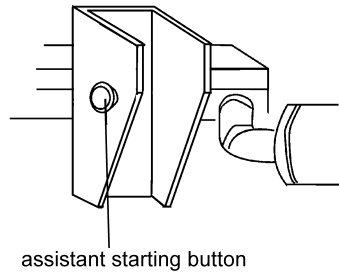

Running-in and Maintenance of New Vehicle

The correct running-in of a new vehicle has a great influence to the vehicle service life and its reliability.

The running-in kilometrage of a new vehicle is specified as 1500~2500km, and the vehicle will be used normally only after 2,500 km's running-in. Because it will reach the peak of its power at that time. Otherwise the insufficient power and earlier overload operation will cause the parts of engine overwear.

You should follow the below rules during the running-in period:

Before Running-in

Clean the vehicle and check the tightness and connecting of every part.

Check the level of the water tank, and the cooling system(to see whether it is leaky or not).

Check the lubricating oil level of the engine, clutch control system, gear box, rear axle, and steering system to see whether the oil should be added, and check whether every part is leaky or not.

Check whether every part of steering is loosen or seized.

Check whether the brake system works normally, and the connecting pipe is leaky or not.

Check whether electrical equipments, lights and instruments work normally. And check the level of the electrolyte of battery.

Check whether the tyre pressure is up to the standard.

Check whether the speeds of gear shift is engaged.

Running-in Period

The vehicle should be run on flat and paved road.

Correctly drive, engaging the clutch smoothly, shifting gear in time, avoid to accelerate suddenly and brake sharply.

Load specified: The load capacity can't be over 70% of rated load during running-in period.

Pay attention to the temperature of gear box, rear axle, wheel hub and brake drum. If the temperature is too high, you should find out the reason and adjust or maintain.

Specially notice the oil pressure and control the normal temperature of the engine coolant.

After Running-in

After the running-in, please go to the truck technical service station to do the running-in service. The service should be carried out according to the "Maintenance Schedule".

Driving Recommendations

Proper driving habits will not only result in longer service life and better performance, but also in greater economy and safety in operation. Be sure to observe the following rules.

1. When the engine is cool, do not start to run hurriedly. Do the cold start, first allow it to be a permissible speed, and the exhaust smoke is bluish-white, so the oil pressure engine combustion will be stable along with the heating of the engine.

2. Never run-up the engine speed unnecessarily. If the temperature of the cooling water is low, it will cause the engine damage. If the temperature is below 0 °C , the engine should run in moderate speed for 5 minutes before full load running.

3. The engine speed can't exceed 2,500r/min before the driving mileage is at 4,000km.

4. Avoid full-throttle starts fully and brake suddenly, the first case will cause the clutch damage or the tyre wear while the second case will accelerate wear on both the tyre and brake linings.



5. Don't overload driving. It will shorten the service life of the vehicle.

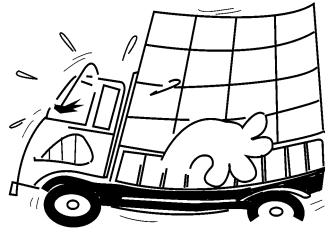

Driving on a slope

When descending a slope, be sure to keep the vehicle speed within a safety, controllable range by utilizing the engine, exhaust brake, and the foot brake.

When down shifting, as well as when descending a slope, engine can't be over 3000 r/min. Excessive running of the engine may cause some of the part to receive under stress and could result in mechanical problems.

Before descending a steep or a long gentle slope, apply the brakes and make sure that the brake system functions normally.

When driving on a downgrade or shifting into a lower gear, make sure of the vehicle speed by checking the speedometer, and the engine revolution by tachometer.

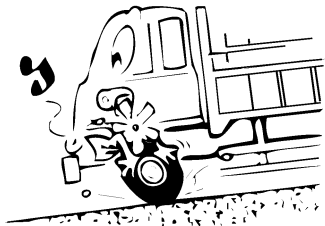

Clutch Operation

When use the clutch, release quickly and thoroughly. To release half-way is one of the reason of clutch damage. Avoid engaging partially

clutch, as this will greatly affect the clutch operation and service life. After the clutch operation, ensure not to step on the clutch pedal. When changing the position of the transmission gear shift lever, both in shifting to higher gear and in downshifting, be sure to use the double-foot-clutch method for shifting.

Double-foot-clutch Method for Shifting

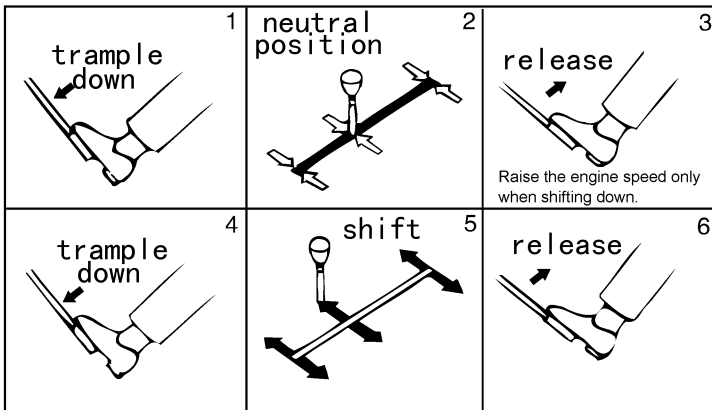

The Use of Warning Triangle

When your vehicle is break-down or has some problems, first light the warning light, then put the warning triangle behind the vehicle nearly 30-100 meters' far. Do remember to put the red side to the com-ings.

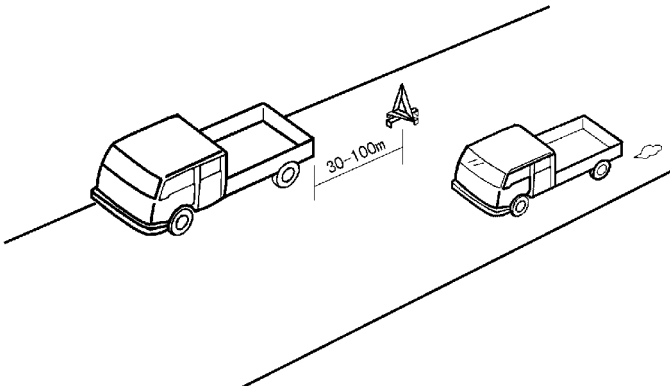

Parking

The vehicle should be parked on a plain place as possible as you can.

Pull up the parking brake lever to locked position, and move the transmission gear shift lever to neutral position. A chock should be placed behind the tyre if it is necessary.

After driving, allow the engine to idle first until the temperature of the engine becomes lower, then shut off the engine. Especially after heavy loaded operation or high speed driving, the temperature of engine is higher and it is better not to stop suddenly.

Turn off all switches after stopping the engine.

Turn the key switch to the LOCK position then take out of the key.

Lock the door.

Vehicle Inspection

Driver's Daily Inspection

Driver's daily inspection on the vehicle directly has effects upon the safety of driving. In order to prevent problems, to assure driving safety, and to know the condition of your truck, the daily inspection should be done by yourself before using the vehicle.



● Before Daily Inspection

- 1.The vehicle should be parked on the flat ground.
- 2.The switch key must be set on the OFF position.
- 3.The parking brake is applied properly.
- 4.The transmission gear shift lever should be in neutral.

● First Inspection

Check the abnormalities you noticed in the previous day.

If the abnormalities were repaired during the previous day, check again to make sure if it was really repaired.

● Before Engine Starting

- 1.Check the driver's seat

The driver's seat should be adjusted to the optimum position for safety.

- 2.Check mirrors

Make sure that all mirrors are clean and provide clear views of all the sides,

Vehicle Inspection

rear, front, left and right (including the rearview mirror).

3. Check lock condition of the door

Make sure that all the doors are securely locked, and the window glass lifter is working properly.

4. Check the fluid level of the windshield washer

Check the fluid level of the windshield washer and add fluid if necessary.

5. Check the cooling water level

1) Before adding cooling water, check the engine and radiator for any sight of leakage, please repair it first if there is. Fill the cooling fluid into the filling hole of the radiator until the fluid is overflow.

6. Check the seal and function of the pressure cover of the filling hole.

Note:

The long-life, antifreezing and antirust coolant is advised. Forbid to use tap water, well water, or river water instead of the cooling fluid. Without using of the coolant fluid, the incrustation scale will appear in the cooling system, and result in the overheating of the engine.

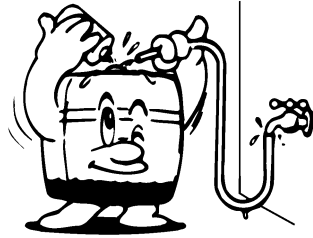

Vehicle External Inspection

Before inspecting, tilt the cab forward.

1. Check the engine oil level

Check the oil level by pulling out the oil level stick. If below L mark, you must fill the specified oil from the oil

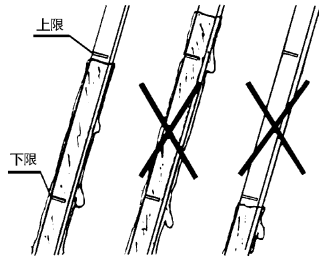

filler of engine until the oil level is up to H mark. If it is above H mark, the surplus oil must be released from the oil-pan plug of the engine.

Note:

If the oil level of engine is lower than required, the engine will be burnt.

2.Check the remaining fuel

The capacity of the fuel tank is 120L, and the max continuous running distance is 500Km. Please check the remaining fuel before driving and decide whether you have to fill the tank according to the driving distance of that very day.

3.Check the brake pipes to see whether it is leaky

4.Check the bolts and nuts of steering system

5.Check the front and the rear leaf spring and their bolts and nuts

6.Check the tyre pressure

7.Check the electrolyte height of battery

8.Check the harness(whether is worn by other parts) and earthing

9.Check each gauge

The needle of the engine oil pressure gauge should be in normal range. If the warning light is lighted for more than 15 seconds, the engine should be shut down immediately.

The needle of the fuel gauge should be between E and F.

The needle of the water temperature gauge should be within the range inside the inner line on the scale.

Whether the speedometer works normally.

Whether the engine fault indicator is off.

10. Check the horn

Press the horn button and make sure the horn sounds normally.

11. Check the windshield wiper and washer

Clean the windshield before the inspection, and then spray the washer fluid and check whether it is operated normally. Also make sure that the wipers operate normally in every speed.

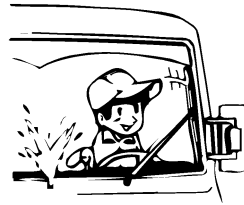

12. Check the front and the rear lamps

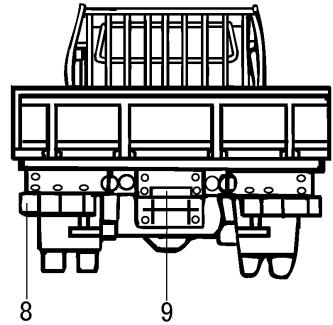
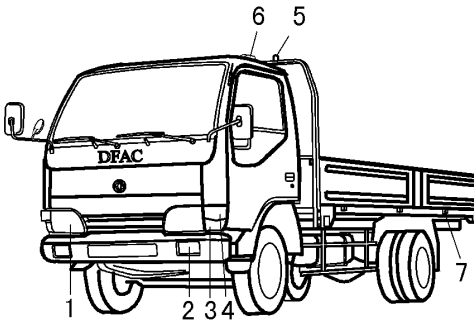

1. Headlamp
2. Front fog lamp
3. Front lamp
4. Turning signal lamp
5. Rear clearance lamp
6. Front clearance lamp

7. Side clearance marker
8. Tail combined lamps (rear turning signal lamp, tail lamp, brake lamp, rear fog lamp, reversing lamp)
9. Licence lamp

Make sure that every light is on when each light switch is connected. It is more convenient to do this inspection by two persons.

13. Check the engine, steering system, transmission and rear axle to see whether there is any leakage.

14. Check the steering wheel for free turning and axial play

With the front wheel set for movement straight ahead, alight rotate the steering wheel clockwise and counterwise to check the play.

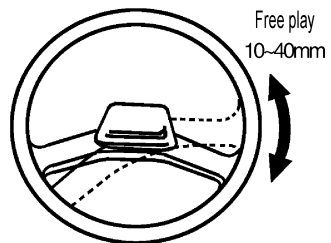

Move the steering wheel in the axial and radial directions. There should be no excessive free play.

15.The exhaust gas inspection

Thoroughly warm up the engine, and check the color of the exhaust gas in order to determine the condition of the engine.

Colorless or light blue: Normal

Black: Abnormal, incomplete combustion.

White: Engine oil is also burning. However, exhaust gas are often white when either air or engine temperature is low.

Also check the engine operating sounds and vibrations for any abnormality.

16.Check the brake.

Depress the brake pedal while driving, and make sure the braking response is normal.

17.Check the steering system

During the test running, make sure that the steering wheel operates normally without shimmying, difficult steering or pulling to one side.

10.Checking after test running.

After test running, parking and then walk around the vehicle to check for any signs of water and air leakage.

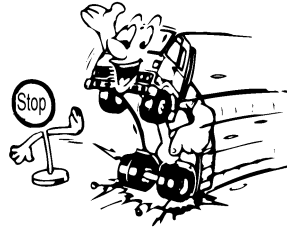

18. Other

The above procedure completes the driver's daily inspection task. If any problems are encountered in this inspection, please get in touch with local agency or repair dealers.

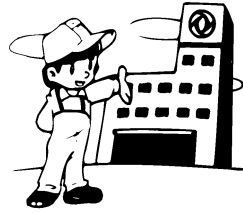

General Maintenance

Air Filter

The air filter cartridge is made of paper. The air filter is consisted of filter cartridge assembly, dust boot, casing and casing cover.

The dust exhausting valve should be placed downward to exhaust the dust.

Check and clean the outer filter cartridge of air filter every 8,000km (4,000km in extremely dusty areas). The method is as follows:

1. Take out the filter cartridge and put it on a plain plate and pat it. Put a light into the filter to check for wear or hole, as well as to check the washer, replace it if there is something abnormal.

2. Using the dry compressed air of 0.5MPa to blow off the accumulated dust from the inside toward the circumference of the circle. Replace the cartridge immediately if any of the following situations appeared:

- a) The outer cartridge has damaged or been cleaned more than 5 hours.
- b) After 48000km.

The safety cartridge can not be cleaned. If the outer cartridge has damaged or been cleaned more than 5 times, you have to replace it.

Note:

Be sure not to take apart the air filter during driving.

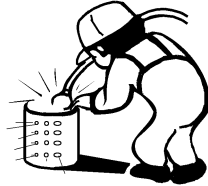
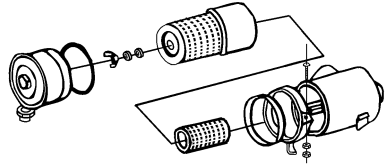

General Maintenance

Do not clean the filter cartridge with gasoline or water.

Check the cyclone boot for wear when clean it, replace it if it is worn.

Install the filter cartridge and cyclone boot correctly, otherwise the dust will come into and shorten the service life of the engine.

When installing, check every seal ring for wear, replace or stick it if it is damaged. Every seal ring should not be lost or missed.

Diesel Oil Prefilter

Drain the water every 12000km, and replace the prefilter every 36000km.

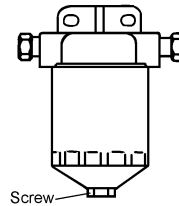

Fuel Filter and Fuel-water Separator

Replace it every 16000km.

Use the special wrench to disassemble the fuel filter and fuel-water separator. Before you installing the filter manually, fill it with clean diesel oil until the sealing surface is engaged with the connecting surface, you can screw for 3/4 circle to tighten it.

Note:

Do not use the special wrench during installation, otherwise it will deform the thread and damage the filter finally.

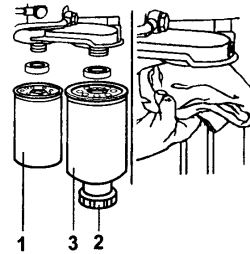

1. Fuel filter
2. Drain valve
3. Fuel-water separator

Oil Filter

The engine is equipped with a spin-on filter for lubricating oil which is one-time used. Replace the oil filter every interval 10,000km. Use special filter wrench to remove the filter. When assemble a new filter, first fill the filter with clean lubricating

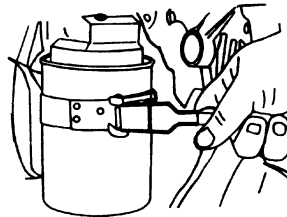

oil, and apply oil on the surface of the oil seal, then assemble the filter by hand. After the sealing surface engaged with the connecting surface, you can screw for 3/4 circle to tighten it. Start the engine to check the sealing surface for leakage. If there is any leakage, tighten it until there is no leakage.

Note:

Do not use the special wrench during installation, otherwise it will deform the thread and damage the filter finally.

Fuel Tank Draining

Screw off the fuel drain plug at the bottom of the tank to drain the dirt and water every 12,000Km. Till the clean diesel oil flow out, screw up the plug immediately. Especially in winter, because the water is easy to ice and cut off the supply of the diesel oil, please do remember to drain.

Fuel Pump

In the pump's fuel pipe, there is a joint bolt is installed a gauze filter to filter diesel oil. Be sure to wash the gauze with clean diesel oil every 4,000km. If damaged, replace it in time, or it will influence the fuel supply.

If the manual pump piston is blocked, check the fuel pipe bolt gauze filter to see whether it is damaged or not. Remove the manual pump assembly and soak it into clean diesel oil for a long time. If it is seized, replace the manual pump assembly.

Exhaust Gas Turbo Supercharger

The lubricating-oil is supplied by the main pressure oil passage of the engine, and the return lubricating-oil will back to the oil pan by the gravity. In order to avoid the leakage of the supercharger and assure its normal operation, pay enough attention to the process of the inlet and return lubricating-oil and assure to their smoothly process. Do not change the shape or area of the return lubricating-oil pipe.

The opening and closing of the exhaust valve of the supercharger is controlled by the supercharger itself, therefore, please note:

- 1.The users can not loosen or tighten the adjusting nut of the connecting rod to adjust the opening pressure of the exhaust valve. Otherwise, it is harmful to the engine.
- 2.Do not load or trample the connecting rod in any case.
- 3.If you find the inlet pipe is leaky or the supercharger is abnormal during driving, stop the vehicle and check them. But do remember the exhaust valve and sealed pressure chamber can not be repaired, and if they are worn , you have to change the turbine casing.

Maintenance of the supercharger:

The supercharger belongs to the high-speed rotating precise

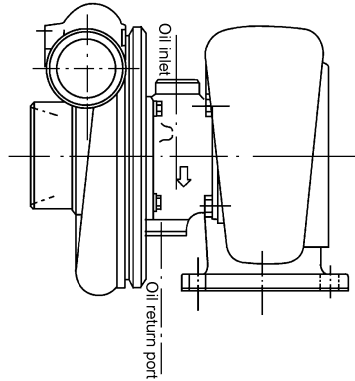

mechanism, therefore, it can not be disassembled if not necessary. But if because of the dust or oily dirt that make the rotor or engine abnormal, you can have a simple cleaning without totally disassembling the supercharger, and the specific operating method is as follows:

1. Get rid of the dust and oily dirt of the surface of the supercharger.
2. Remove the supercharger from the engine but do not carry it by the connecting rod.
3. Remove the inlet pipe first then the exhaust valve adjustment.
4. Remove the compressor casing, turbing casing and inlet and return oil flange.
5. Clean the compressor casing, turbing casing and the surface of the two impeller.
6. Fill some clean washer liquid from the inlet and rotate the impeller by hand until the impeller works well.
7. Assemble and install to the engine.

Note:

Do not hit or knock the impeller vane during disassembling, assembling and cleaning. If there is any hit or knock, do not use the rectified blade again. The cleaning liquid could be kerosene, gasoline or high quality diesel oil.

Air Drier

After 100,000km, check the air tank for water. If there is, you should replace the air drier.

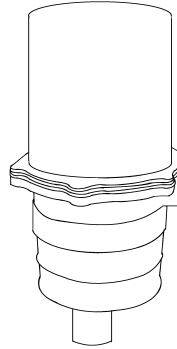

Check the Oil Level, and Refill the Clutch Oil Reservoir

The oil reservoir of the clutch is located in the cab. The fluid level in normal condition is between MIN and MAX, if it is below MIX, refill it.

Check the pipe line before adding fluid. Repair it if there is leakage.

Note:

Do not use the different quality or different brand of fluid.

Never use mineral oil as the clutch fluid.

Be sure to use clean clutch fluid.

Be careful not to get the fluid on any painted surfaces, otherwise the paint will be damaged.

Use special care to seal off the clutch fluid, because the clutch fluid will absorb the moisture of the air.

Be extremely careful not to allow dirt or dust enter the reservoir. Make sure that the reservoir and its surrounding areas are clean before adding or replacing the clutch fluid.

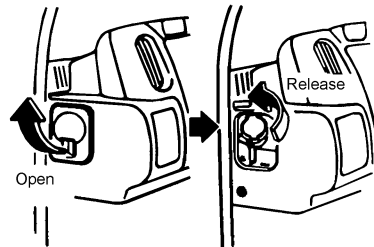

The Transmission Lubricating Oil

Check the oil level of transmission lubricating oil every 4,000 km. First screw off the check plug, if the oil level

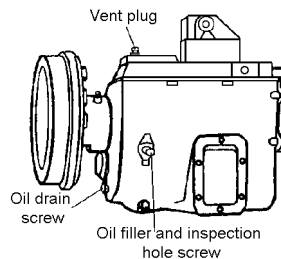

is below the edge of the plug, add oil. Then check the function of vent plug and clean it.

Replace the transmission lubricating oil under the truck heated condition every 24,000 km. Screw off the drain plug first, drain off the oil in the transmission. Then clean the drain plug (the magnet on the drain plug which collects accumulated iron sediment in the oil) and reassemble, refill the new lubricating oil through the check plug hole.

Note:

If the oil level is too low, the bearing and gear will be burnt, and if too high, it will cause overheat and oil leakage.

Keep the vent plug fluent.

Be careful not to allow any dirt or dust enter the gear box.

The Rear Axle Main Reductor Lubricating Oil

Check the lubricating oil level of main reductor every 12,000 km. Screw off the oil level check plug first, if the oil level is below the edge of checking hole, add oil. Then check the function of drain plug and clean it.

Replace the lubricating oil of the main reductor every 24,000 km. Screw off the drain plug first, drain off the oil, then clean the drain plug and reassemble it. Refill the new lubricating oil through the filler hole.

Note:

Fill the lubricating oil according to the requirement. Do not use the normal gear oil

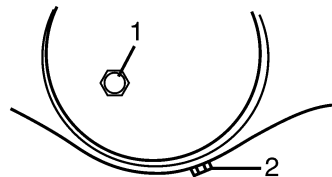

1. Inspection screw
2. Oil drain screw

General Maintenance

instead, otherwise it will damage and rub the gear face quickly.

Be careful not to allow any dust or dirt enter the main reductor.

Keep the oil level at normal height, overheight or overflow will effect the service.

Keep the vent plug fluent.

Power Steering Lubricating Oil

Before check the oil level, clean the oil reservoir first, then screw off the oil filler cap with oil level stick. Clean the stick and reassemble it, then remove again to see the oil level. If the height of the oil level does not between the high and low scale of the oil level stick, it need to be filled with same brand hydraulic oil.

Check the lubricating oil every 4000km, and if it is insufficient, please refill it to the oil filler edge.

Replace the steering oil every 4,8000km.

Replace the oil of power steering fluid every 2,4000km.

Replace procedure:

1.Block the rear wheel with triangle bolster, set the transmission to neutral and rise the front axle with the jack to make the wheel away from the ground.

2.Screw down the inlet and outlet oil tube joint to exhaust the steering system oil, and start the engine at the same time, turn the steering wheel.

3.After make sure the oil has been drained off, open the cap of the oil

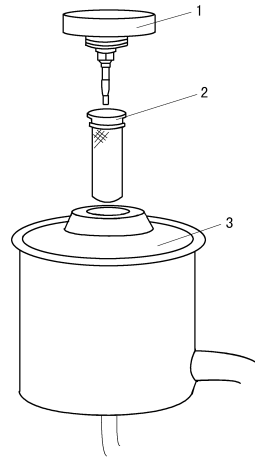

- 1.Oil filler cap with oil level stick
- 2.Hydraulic oil cartridge
- 3.Oil reservoir

reservoir to replace the hydraulic oil cartridge.

4. After replace the cartridge, first refill the oil reservoir and then start the engine to idle for a short time, then cut off the engine and refill the hydraulic oil. Do this process for several times until the oil level is between the MAX and MIN of the oil level stick.

Note:

Forbid to refill the hydraulic oil during engine running.

During engine idling, turn the steering wheel at clockwise and counter clockwise to help exhausting the air in the system.

You must cut off the engine when you check the oil level.

Battery Checking and Maintenance

Before checking the battery system, be sure to cut off the main power switch.

● Check the battery liquid

Check the battery liquid monthly or every 4,000 km. The liquid should be above the plate 15 to 20 mm. If it's lower than that, add distilled water, and charge the battery for 30 minutes until the distilled water mixed with the battery liquid.

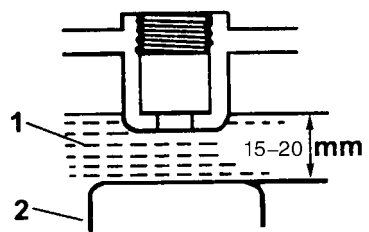

1. Electrolyte

2. Plate

● Checking specific gravity of electrolyte

Check specific gravity of electrolyte every 12,000km or three months. Use the hydrometer to check. The normal specific gravity is between 1.26~1.265 (when the electrolyte temperature is 20 °C) . If the specific gravity is less than 1.22, the battery must be recharged.

Note:

Never use thick lead or tool earth connect the two poles of battery and other short circuited method (observing the strong and weak of the electric spark) to check the electric capacity.

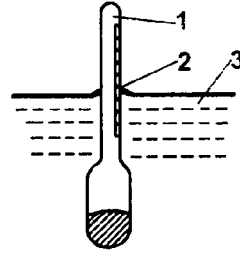

- 1.Float
- 2.Reading
- 3.Level of electrolyte

Fuse

Be sure to affirm the load of fuses before replacing. If the new fuse are blown easily, you should find out the reason and repair it.

Note:

Never use normal lead or the fuse with other load instead.

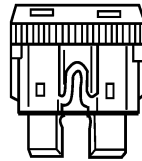

Normal

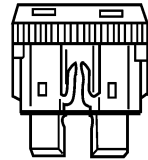

Burnt

Suspension

After the running-in of new truck, tighten the U-bolt and nut of leaf spring under the certain torque of fully laden condition.

The tightening torque of front leaf spring U-bolts and nuts is 250~300N.m; the tightening torque of rear leaf spring is 300~350N.m.

Tighten the leaf spring U-bolts and nuts every 12,000km.

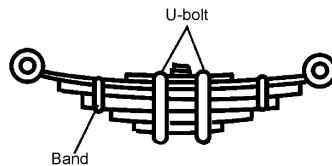

Tire Rotation

Rotate the tires according to the picture every 12,000Km. The principle for tire rotation is as follows:

1.The differential of outer diameter of two rear axle tirs is no more than 12mm. Mount the smaller one to the inside wheel.

2.Mount the same type, less wear and blanced tires on the front wheel.

3.After rotation, the turning direction of tires should be opposite from its former mounting direction.

4.New tires must be used in pair.

5.Be sure to mount the tires of the same size in the same shaft, otherwise it will cause braking deviation, cab swing and lost controlled steering.

6.Check whether there is any scars on the wheel hub bolts and wheel nuts. For the sake of the safty, whenever there is screw damage in bolt or nut, it must be replaced in pairs as the other part may also be damaged.

7.Check the connecting (ball) surface of the tire rim and the installing hole to see whether there is any deformation or damage. If there is, replace it. And if there is any damage on the ball surface of tire nut, replace it, too.

8.Check the rim of the tires, if there is any cracks, replace it.

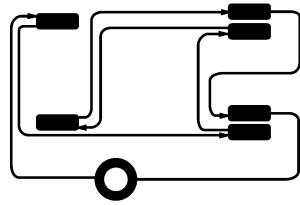

9. When mount tires in pair, the air intake-outer and the air intake-inner must be separated in order to breathe air in.

Clean and Replace the Wiper Blades

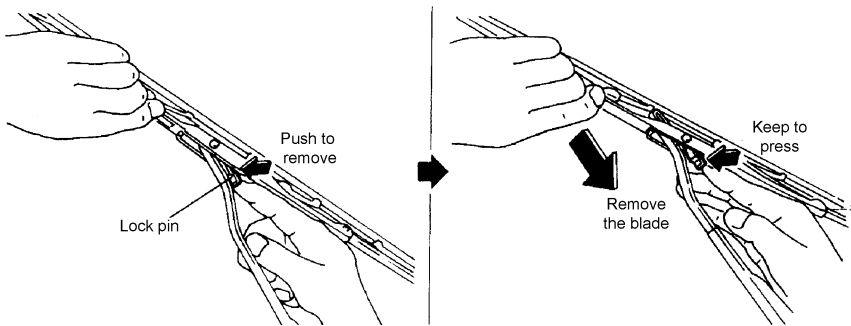

● Clean the Wiper Blades

After using the wipers, if the window glass is still not clean, this may be caused by uncleanness of the wiper blades, at this point, the blades need to be cleaned. First, wash the windshield with washing liquid or special washing fluid, and wash the blades with cloth soaked with washing liquid or special washing liquid, then wash off the liquid or fluid with water.

● Replace the Blades

After the wiper blades are cleaned, if it still could not clean up the window glass, replace it.

The procedure for replacement is as follows:

1. Pull out the wiper arm
2. Untighten the lock pin, and push to remove the blade
3. Install a new blade into the wiper arm, if a sound "clicks" can be heard, it shows that the blade is well fixed.

General Adjustment

Using Engine in a Environmental Protection Standard

● Note:

1.As for those who dismantle the leaden seal of engine without permission, the DongFeng Automobile Co., Ltd would consider they have given up the right of obtaining service.

2.The engine has been reached the requirements of national environment law before leaving the factory, so the users can not change or adjust it. Only in those recommended service station or agencies of DongFeng Automobile Co., Ltd, the engine could be adjusted, otherwise, it will be treated as given up the right of obtaining service.

3.During the maintenance you should follow the principles below:

- a) Do the maintenance or change the three filters at a certain interval and you have to quiken your changing step if the outside driving condition is severely bad.
- b) Use the specific or recommended oil and change them at certain intervals.
- c) Use different type of diesel oil of high quality according to the local temperature.
- d) Please do not allow the shortage of engine liquid or lubricating oil.

- e) Check the supercharger, intercooler, and the seal condition of the in and out pipe, avoid the leakage.
- f) The start and stop of the engine.

To assure the normal using of the engine, the users should idle the engine for 3 to 5 minuts before moving to lubricate the engine parts, especialy the supercharger. Do not full throttle to warm up the engine after starting. Please idle the engine for 3 to 5 minutes before stopping to cool the engine parts, especially the supercharger to avoid the gel and carbon deposit of the lubricating oil on the heating parts. It will cause trouble.

7. Use the recommended oil filter and diesel oil filter catridge.

8. Check the clearance of the inlet and outlet valve following the guidance of the instructions.

9. The idling revolution has its own normal standard, so the users can not adjust, because the low idling revolution will cause the accelerated smoke accceed quota.

Drain Water Out from the Cooling System

If the vehicle park for a long time in winter, you should drain out the water of the cooling system if there is no anti-freeze fluid used to avoid cylinder block and radiator frost-cracking.

Note:

Open the cap of radiator while the engine is hot, be sure to turn the radiator cap slowly to low pressure position to reduce the inner pressure to avoid the hurt by the hot water injection.

Check the Opening Temperature of the Thermostat

Check the thermostat working condition in hot water while perform the 48,000km maintenance.

The opening temperature of the thermostat is 76 °C and 86 °C

The full opening stroke of the thermostat: not less than 6mm (3~5min, in boiling water).

Note:

The thermostat is necessary for engine to keep normal working, so it can not be removed arbitrarily.

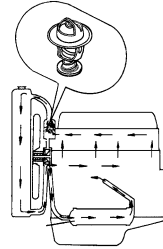

Adjustment of Fan Belt

The tightness of fan belt should be checked frequently. The checking method is like this, press the belt at a force of 29~39N to see whether deflection is in the range of 10~15mm (Note: Both belts should meet the requirement). Over tighten will damage the bearing of water pump and the bearing of generator, over loosen will cause the belt slipping, low cooling efficiency and engine over heating.

Change the relative position of adjusting arm to the generator to adjust the tightness of fan belt.

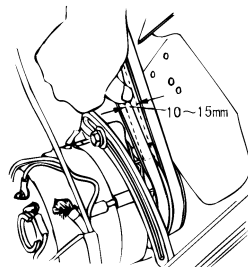

Pump Fuel Manually and Bleed Air Out of Fuel Supply System

Loosen the bleed screw (1) on the injection pump and the screw located above the diesel filter, and screw out the handle screw cap (2) of fuel supply pump, take out the handle up and down till the there is no bubble in the flowing fuel out from the screw, then tighten the screw and the handle screw cap.

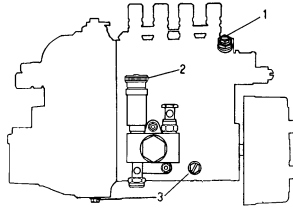

- 1.Bleed screw
- 2.Handle screw cap
- 3.Drain plug

Water-leak Hole of the Water Pump

The water-leak hole under water pump body is used to leak the water from the water seal, so keep the hole not being blocked is very important, thus the water will not be remained inside the water pump cavity to damage the bearing lubrication.

If the water leaks a lot from the hole while parking, dismantle the water pump for repairing.

Air Valve Clearance Adjustment

Check and adjust the air valve clearance every 12,000km, and the normal clearance is (under cold condition):

Inlet valve: 0.25mm

Exhaust valve: 0.50mm

No matter the clearance is too large or too small are harmful to the engine. If you find the noise of the air valve is too loud during using, you must adjust it in time. The air valve clearance

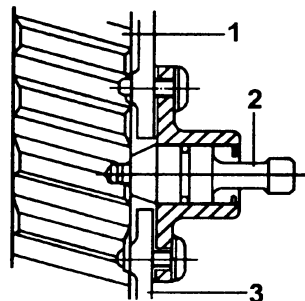

- 1.Camshaft gear
- 2.Timing of pin
- 3.Gear case cover

adjustment should be done under the cold engine.

Adjusting method:

- 1.Remove the air valve cover.
- 2.Press the timing pin of the engine(on the timing gear chamber close to fuel injecting pump), and use a wrench to turn the engine slowly until the timing pin is inserted into the timing hole of the camshaft gear and the 1st cylinder is in the compressed top dead center.
- 3.During this time, you must adjust the following air valve clearance(counted from the front to the end): valve 1(inlet), 2 (exhaust), 3 (inlet), 6 (exhaust).
- 4.After the adjustment, make marks on the pulley and the timing gear chamber, then turn the engine to align the marks.
- 5.Then adjust the following air valve clearance: 4 (exhaust), 5 (inlet), 7 (inlet), 8 (exhaust).

Note:

When you have found the top dead center of the 1st cylinder, you must first drop out the timing pin then you can adjust the air valve clearance.

Adjustement of Clutch

The clutch is controlled by hydraulic mechanism, the adjustment method for the total travel and free travel of the pedal is as below:

- 1.Adjust the clearance between the push rod and the piston of master

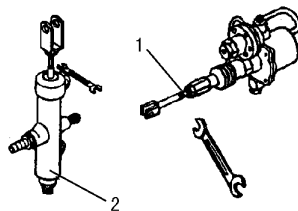

1. Slave cylinder 2. Master cylinder

General Adjustment

cylinder to 0.2~0.7mm. When made the adjustment, loosen the lock nut and turn the push rod towards the piston, when the push rod touch the piston, withdraw the push rod by 1/7~1/2 pitch, then tighten the lock nut.

2.Adjust the free travel of slave cylinder push rod to 3~5mm and tighten the lock nut.

3.After the above adjustments has finished, the travel of master cylinder push rod and slave cylinder push rod should be 20~24mm, and 17~20mm, the free travel of clutch pedal should be 30~40mm.

Air Release of Clutch

The existence of air in clutch hydraulic system may lead to abnormal work for clutch control system, therefore it is necessary to release air. The method is like this:

1.Fill up the clutch oil reservoir with composite brake liquid, and make the air pressure of the air tank reached to 650kPa.

2.First remove the dust cap of clutch slave cylinder, and loosen its bleeding bolt, then engage a matchable hose to bleeding bolt at one end and put the other end into a bottle filled with brake fluid, and then trample the clutch pedal repeatedly until some air bubbles come out.

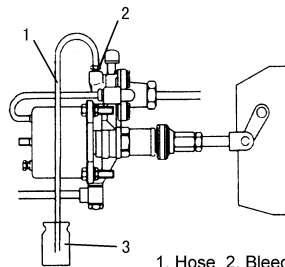

1. Hose 2. Bleeding bolt
3. Bottle with brake fluid

3.Screw on the bleeding bolt, trample down the clutch pedal, then screw off the bleeding bolt to exhaust the air in the oil, then screw on again and release the clutch pedal.

4.Do the 3rd step repeatedly until there is no bubbles come out and you can feel the clutch can be disengaged totally.

Adjustment of Brake Clearance

In normal condition, the brake clearance is between 0.6mm~0.8mm.

After replace the brake shoe lining, you must have a completely adjustment to the brake , the method is as follows:

Use the wrench to first turn the adjusting arm worm shaft to achieve the full contact of the brake shoe surface abd brake drum surface, then turn it loose for 1/2~2/3 circle(at that time the clearance between the center of the fricton lining and the brake drum is about 0.7mm), and the brake drum hub assembly can turn freely without any interface to other parts.

The spring brake chamber do not need maintenance, but examine and repair once after 2 years using.

Check: The starting pressure of the diaphragm cylinder is 20~30kPa. If the pressure rise to 50kPa, you have to check it. Under the condition of wheel brake in proper adjustment, the diaphragm travel should be 1/3 of the possible total diaphragm travel. At this time,

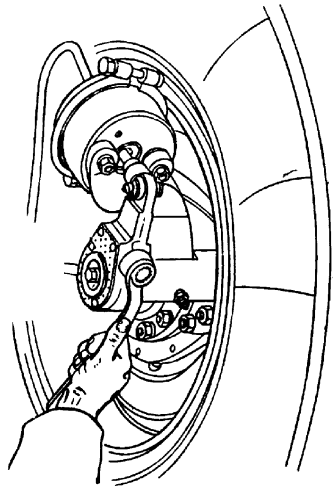

General Adjustment

under the condition of full brake, the angle between push rod and brake cam adjusting arm is 90° .

The release pressure of the spring accumulator should be no more than 600kPa, and if you find the release pressure becomes low, the spring accumulator should react immediately.

Note:

When adjusting the push rod, its travel should not be over the effective travel.

Brake system

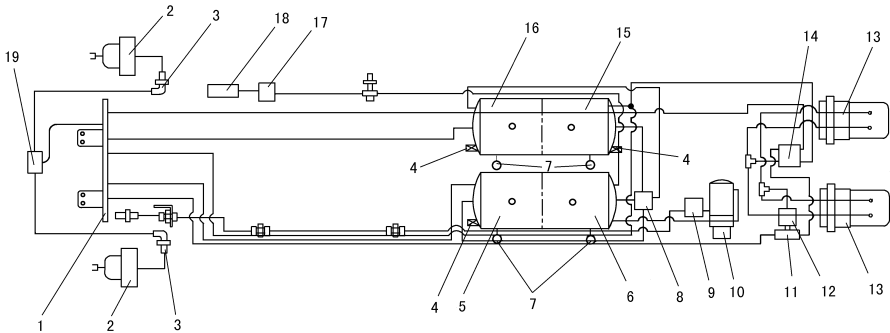

- | | |
|---------------------------------|--------------------------|
| 1.Bracket-hose | 11.Two-way valve |
| 2.Front-brake chamber | 12.Quick-release valve |
| 3.Elbow joint | 13.Rear-brake chamber |
| 4.Alarmer | 14.Loading sensing valve |
| 5.Parking air tank | 15.Rear air tank |
| 6.Wet air tank | 16.Front air tank |
| 7.Drain valve | 17.Electromagnetic valve |
| 8.Four-circuit protection valve | 18.Exhaust brake valve |
| 9.Unloader valve | 19.Quick-release valve |
| 10.Air drier | |

Adjustment of wheel hub bearing

Every 12,000km, the wheel hub bearing should be maintained. Dismantle the wheel and brake drum, clean the wheel hub bearing, then the dirt and deteriorative grease in the inner hole of the wheel hub. Fill up the space between the inner retainer and rollers with the new grease, and apply a coat of grease on the bearing surface. Then reassemble the wheel hub bearing.

Adjustment for the front wheel hub bearing

Tighten the locking nut with a torque of 120~150N.m and turn the wheel 2~3 turns to ensure the bearing in proper position. Then turn back the locking nut about 1/3 turn to set the locating pin on the locking nut align the hole of lock washer, if they can not align, turn the locking nut out a little until align to the cotter pin.

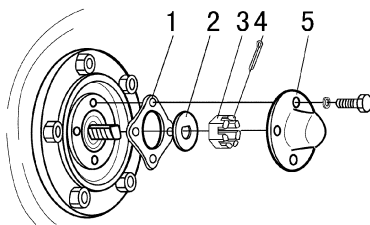

- | | |
|----------------------|---------------|
| 1.Spacer | 3.Locking nut |
| 2.Anti-friction shim | 4.Cotter pin |
| | 5.Hub cover |

Adjustment for the front wheel hub bearing

Tighten the hub bearing nut with a torque of 150~180N.m, in the meantime rotate the wheel to set the bearing roller in the proper position, then loosen the nut for 1/6 turn and set the hole on the bearing nut align the hole of lock washer. Finally tighten the setting screw, the bearing can rotate freely, no axial play is found.

Note:

Carefully disassemble and reassemble the wheel hub avoid to be damage.

Don't lose the outer oil seal retainer.

The inner oil seal should be smeared with grease when renewing.

Pay attention to the temperature of the wheel hub during running in about 10km, after adjusting the wheel hub bearing. If the temperature is too high, the bearing will be too tight, so the adjustment should be applied.

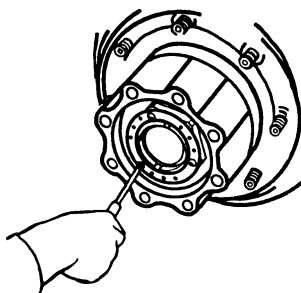

Adjustment of Free Play of Steering Wheel

Check the free play of steering wheel every 12,000km, which is under

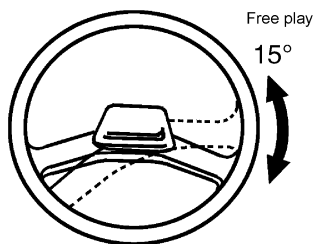

15° normally. If it is too large, check and adjust the following part:

Check and adjust the clearance of the bearings of the front wheel hub.

Check the tightness of tie rod ends and drag link joints, and adjust them.

Check whether the fastening bolts are loosen at the connection of the spline of the pitman arm and its shaft.

Adjustment for Toe-in

Check and adjust toe-in every 12,000km, which recommend value is 0~5mm, if toe-in is adjusted improperly, the tyre wear would be increase.

The adjusting method is as follows:

Park the truck on a level ground before checking, the front axle is lifted by a jack, the front wheels are put to run straightly. Screw off the clamp bolts on tie rod, turn the tie rod with pipe wrench and the proper value of toe-in can be achieved by adjusting.

Make a mark in the middle of tyre engraving of the right and left tyre when adjusting, then measure A, B value respectively in the front of the axle and behind it.

After adjusting, if the condition is permitted, check the side sliding of tyres. The specified side sliding is between 3~5mm/m.

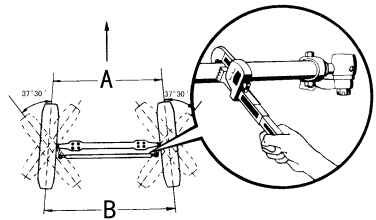

Maintenance Schedule

It's necessary for periodical inspection and maintenance of truck to prolong its service life, improve its power performance and fuel economy, so periodical inspection and maintenance should be carefully carried out according to the following items. Then it will achieve the max economic and social benefits.

The users have to do the maintenance accord with the specific content in this chapter. The following schedule is not only for maintenance items of 80,000km, but also for normal maintenance items after 80,000Km.

☆——Running in maintenance items:1,500~2,500km

★——Normal maintenance items

Note:

Customers should carry out the inspection and maintenance intervals according to the different area condition. Properly shorten the maintenance intervals can ensure the truck to get the reasonable maintenance and move reliability. Never prolong the intervals.

Engine

Maintenance Items	Maintenance Intervals (× 1000km)													
		4	8	12	16	20	24	28	32	36	40	44	48	80
Clean engine assembly		★	★	★	★	★	★	★	★	★	★	★	★	
Check the performance of accelerating and decelerating	☆	★	★	★	★	★	★	★	★	★	★	★	★	
Check the condition of exhaust	☆	★	★	★	★	★	★	★	★	★	★	★	★	
Check engine lubricant oil for leakage	☆	★	★	★	★	★	★	★	★	★	★	★	★	
Check the cleanness and capacity of lubricating oil		★	★	★	★	★	★	★	★	★	★	★	★	
Check fuel system for leakage	☆	★	★	★	★	★	★	★	★	★	★	★	★	
Check cooling system for leakage	☆	★	★	★	★	★	★	★	★	★	★	★	★	
Check the fan belt for damage	☆	★	★	★	★	★	★	★	★	★	★	★	★	
Clean up the sediment of fuel prefilter	☆	★	★	★	★	★	★	★	★	★	★	★	★	
Check and clean air filter and its cartridge	☆		★		★		★		★		★		★	

Maintenance Schedule

Engine

Maintenance Items	Maintenance Intervals (× 1000km)															
		4	8	12	16	20	24	28	32	36	40	44	48	80		
Replace lubricant oil of engine	☆	★		★		★		★		★		★		★		
Replace oil filter	☆	★		★		★		★		★		★		★		
Check and adjust the valve clearance	☆			★			★			★				★		
Change the fuel filter and fuel-water separator				★			★			★				★		
Replace air filter cartridge							★							★		
Check compressing pressure														★		
Check the injection pressure														★		
Check the injection timing														★		
Check the injection flow for injection pump														★		
Check the oil supply pump for its operation														★		
Check the function for the thermostat														★		
Check the working conditions of the radiator														★		
Clean the engine cooling system														★		
Check the working condition of the supercharger, replace it if necessary														★ ★		

Clutch

Maintenance Items	Maintenance Intervals (× 1000km)															
		4	8	12	16	20	24	28	32	36	40	44	48	80		
Check working condition of clutch	☆	★	★	★	★	★	★	★	★	★	★	★	★	★		
Check clutch pedal free play	☆	★	★	★	★	★	★	★	★	★	★	★	★	★		
Check hydraulic pipe line and pump for leakage	☆	★	★	★	★	★	★	★	★	★	★	★	★	★		
Check the slave cylinder for leakage	☆	★	★	★	★	★	★	★	★	★	★	★	★	★		
Check brake fluid level in clutch oil reservoir	☆	★	★	★	★	★	★	★	★	★	★	★	★	★		

Clutch

Maintenance Items	Maintenance Intervals (× 1000km)													
	4	8	12	16	20	24	28	32	36	40	44	48	80	
Change hydraulic oil of clutch													★	

Transmission

Maintenance Items	Maintenance Intervals (× 1000km)													
	4	8	12	16	20	24	28	32	36	40	44	48	80	
Clean transmission and its vent plug	☆	★	★	★	★	★	★	★	★	★	★	★	★	
Check transmission oil level	☆	★	★	★	★	★	★	★	★	★	★	★	★	
Check transmission for oil leakage	☆	★	★	★	★	★	★	★	★	★	★	★	★	
Change transmission lubricant oil	☆						★							★
Check the connections of control mechanism for looseness	☆						★							★
Check working condition of every bearing														★
Disassemble and check transmission														★

Brake System

Maintenance Items	Maintenance Intervals (× 1000km)													
	4	8	12	16	20	24	28	32	36	40	44	48	80	
Check brake pedal free play	☆	★	★	★	★	★	★	★	★	★	★	★	★	
Check effectiveness of brake and parking brake	☆	★	★	★	★	★	★	★	★	★	★	★	★	
Check brake line and valve for leakage	☆	★	★	★	★	★	★	★	★	★	★	★	★	
Check and adjust the clearance of brake drum and lining	☆	★	★	★	★	★	★	★	★	★	★	★	★	★
Check the tightness of the brake support plate	☆			★			★			★				★
Check brake drum and brake shoe for wearing							★							★

Brake System

Maintenance Items	Maintenance Intervals (× 1000km)													
		4	8	12	16	20	24	28	32	36	40	44	48	80
Check working condition of air compressor													★	

Steering System

Maintenance Items	Maintenance Intervals (× 1000km)													
		4	8	12	16	20	24	28	32	36	40	44	48	80
Check steering gear for oil leakage	☆	★	★	★	★	★	★	★	★	★	★	★	★	
Clean steering gear		★	★	★	★	★	★	★	★	★	★	★	★	
Check steering wheel for free play and operating	☆			★			★			★			★	
Check tightening condition of tie rod ends and drag link joints	☆			★			★			★			★	
Check tightening condition of steering mechanism and brackets	☆			★			★			★			★	
Check tightening condition of knuckle arm and pitman arm of the steering	☆			★			★			★			★	
Check and adjust toe-in	☆			★			★			★			★	
Check front wheel alignment													★	
Check and adjust steering gear													★	
Dismantle and check tie rod ends and drag line joints														★
Have a magnetic detection for steering knuckle														★
Change steering ball joint pin													★	
Check the oil level of the steering oil reservoir	☆	★	★	★	★	★	★	★	★	★	★	★	★	
Replace the steering drive shaft							★						★	

Suspension System

Maintenance Items	Maintenance Intervals (× 1000km)													
	4	8	12	16	20	24	28	32	36	40	44	48	80	
Check shock absorber for oil leakage and fasten bracket bolts	☆	★	★	★	★	★	★	★	★	★	★	★	★	
Clean front, rear leaf spring and shock absorber		★	★	★	★	★	★	★	★	★	★	★	★	
Tighten U-bolts and nuts of leaf spring during full load	☆			★			★			★			★	
Check shock absorber for looseness and damage				★			★			★			★	
Check pin bushing of rear leaf spring for wear and damage, change it if necessary													★	
Check shock absorber for malfunction														★
Dismantle and check leaf spring, change spring pin and pin bushing														★

Propeller Shaft

Maintenance Items	Maintenance Intervals (× 1000km)													
	4	8	12	16	20	24	28	32	36	40	44	48	80	
Check shaft joint for looseness	☆		★			★			★				★	
Check tightening condition of spider bearing of propeller shaft	☆												★	
Check tightening condition of midship shaft bearing	☆												★	
Check propeller shaft splines for wear and damage													★	

Axle and Wheel

Maintenance Items	Maintenance Intervals (× 1000km)													
		4	8	12	16	20	24	28	32	36	40	44	48	80
Clean front, rear axle assembly and wheel assembly		★	★	★	★	★	★	★	★	★	★	★	★	
Check reduction gearbox for oil leakage	☆	★	★	★	★	★	★	★	★	★	★	★	★	
Check tightening condition of axle shaft bolt and wheel nut	☆	★	★	★	★	★	★	★	★					
Check tire pressure	☆	★	★	★	★	★	★	★	★	★	★	★	★	
Check tire for wear and damage		★	★	★	★	★	★	★	★	★	★	★	★	
Check lubricant oil level in reduction gearbox and clean vent plug				★			★			★			★	
Clean and adjust wheel hub bearing				★			★			★			★	
Change main reduction gearbox oil	☆						★						★	
Rotate tires				★			★			★			★	
Check working condition of reduction gearbox of rear axle and its bearing													★	
Disassemble, check, and adjust reduction gearbox assembly of rear axle														★
Do the magnetic inspection to the half shaft sleeve														★

Others

Maintenance Items	Maintenance Intervals (× 1000km)													
		4	8	12	16	20	24	28	32	36	40	44	48	80
Check battery electrolyte level (fill up if insufficient)	☆	★	★	★	★	★	★	★	★	★	★	★	★	
Check specific gravity of battery electrolyte				★			★			★			★	
Check chassis frame rivets for looseness							★						★	
Check the tilt locking equipment for its function and damage							★						★	

Others

Maintenance Items	Maintenance Intervals (× 1000km)													
		4	8	12	16	20	24	28	32	36	40	44	48	80
Check connections of cab for looseness	☆	★	★	★	★	★	★	★	★	★	★	★	★	★
Check crossmember sidemember connection for looseness							★						★	

Main Adjusting Data

Engine

Adjusting Items		Standard
		EQB140-20
Air valve clearance (cold)	Inlet valve	0.25mm
	Exhaust valve	0.50mm
Min. oil pressure of idling		69kPa
Min. oil pressure of rated revolution		207kPa
Opening pressure of pressure adjusting valve		414kPa
Opening pressure of oil filter by-pass valve		138kPa
Opening pressure of radiator cover steam valve		System temperature 104 °C : 103kPa 99 °C : 48kPa

Chassis

Adjusting Items	Standard	
Clutch booster push rod travel	Free travel	3~5mm
	Total travel	17~20mm
Free travel of clutch pedal	30~40mm	

Chassis

Adjusting Items	Standard
Free play of brake pedal	35~40mm
Front/rear brake air chamber push rod travel	25~40mm
Final reduction planetary gear side clearance	0.20~0.30mm
Differential gear clearance	≤ 0.8mm
Front/back adjusting distance of steering wheel	35mm
Upper/down adjusting distance of steering wheel	± 15mm
Battery electrolyte gravity	1.26~1.265

Fuel

The qualified light diesel oil specified by GB252-87 could be applied for, and the users choose different qualified light diesel oil according to the local temperature.

Temperature range of the recommended light diesel oil:

Type	Temperature
0# Light diesel oil	Local temperature above 4 °C
10# Light diesel oil	Local temperature above -5 °C
20# Light diesel oil	Local temperature between -5 °C ~ -14 °C
35# Light diesel oil	Local temperature between -14 °C ~ -29 °C
50# Light diesel oil	Local temperature between -29 °C ~ -44 °C

Grease Application Place and Schedule

Greasing should be performed periodically for all parts of the vehicle.

Before filling up, clean all dust and dirty from the grease nipples and other parts which are needed to lubricated, then apply grease.

After greasing, wipe off the excess grease. Be sure to put the caps back on.

The table includes first several kilometers lubricating schedule. You have to follow the schedule after the first several kilometers.

☆——Running-in maintenance lubrication item (running-in maintenance mileage 1,000~2,500km)

★——Normal driving lubricating item

Place of Lubrication	Lubrication Interval Kilometerage (× 1000km)												
	4	8	12	16	20	24	28	32	36	40	44	48	
Reductor assembly	☆		★			★			★			★	
Hub bearing	☆		★			★			★			★	
Adjusting arm	☆		★			★			★			★	
Cam bracket	☆					★						★	
Spides bearing of propeller shaft	☆	★	★	★	★	★	★	★	★	★	★	★	
Middle bearing of propeller shaft	☆	★	★	★	★	★	★	★	★	★	★	★	
Slip yoke of propeller shaft	☆	★	★	★	★	★	★	★	★	★	★	★	
Pins of front and rear leaf springs	☆	★	★	★	★	★	★	★	★	★	★	★	
Steering knuckle pin	☆	★	★	★	★	★	★	★	★	★	★	★	
Ball pin of tie rod	☆	★	★	★	★	★	★	★	★	★	★	★	
Ball pin of drag rod	☆	★	★	★	★	★	★	★	★	★	★	★	
Slip yoke of steering drive shaft and spider bearing	☆	★	★	★	★	★	★	★	★	★	★	★	
Wheel hub bearing			★			★			★			★	
Front bearing of gearbox first shaft	☆		★			★			★			★	
Door hinge						★						★	
Tilt locking system	☆		★			★			★			★	
Supporting point of tilt torsional bar arm	☆		★			★			★			★	
Clutch release bearing												★	

Lubricant and Vehicle Used Fluid

Place of Lubricatng	Lubricant	Type	Grade
Engine lubricating system	Oil	15W-40	CG-4/SH

Lubricant and Vehicle Used Fluid

Place of Lubricatng		Lubricant	Type	Grade
Gearbox		Gear oil	85W/90	GL-4
Power pipe	steering	Hydraulic transmission oil	NO. 8 (used below 10 °C)	Grade CD
		Oil	15W/40 (used above 0 °C)	
Final gear	reduction	Vehicle gear oil under heavy load	85W/90	API GL-5
Clutch system	boosting	Synthetic brake liquid	901-4	DOT4
Hub bearing		Li - b a s e Lubricant grease	NO. 2	SH0535-93
Engine system	cooling	Freezbite, anti-rust coolant		DF series

Engine Lubricant

The following high quality lubricant is recommended for the Cummins Engine:

The lowest standard: CF-4/SG 15W-40

Recommended: CG-4/SH 15W-40

Best: CH-4/SJ 15W-40

Note:

If you use the CD15W-40 or CE15W-40 lubricant below this, it may cause engine damaged, and it is out of the service right.

15W-40 is used under the environment temperature between -10 °C and -15 °C .

10W is used under the environment temperature between -5 °C and -20 °C .

5W-30 is used under the environment temperature below -25 °C .

Gear Oil

API GL-5 gear oil is recommended for gear, the recommended ambient temperature range for all gear oil is below

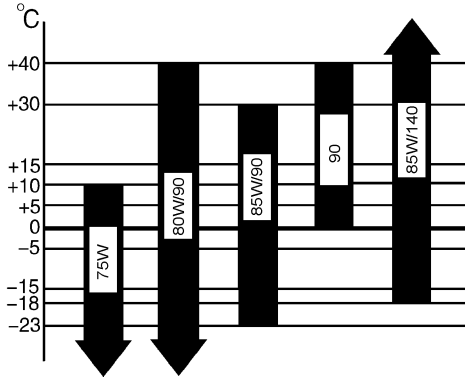

Transmission Gear Oil

Middle load vehicle gear oil 85W/90 GL-4 is recommended.

Lubricating Grease

Vehicle Li-base lubricating grease is used in lubricant points of wheel hub and chassis.

Shock Absorber Oil

Special shock absorber oil is recommended.

Clutch Boost Liquid

DOT 4 synthetic brake liquid is recommended.

Note:

The clutch liquid of different factory and brand can not be mixed to use.

Engine Anti-freeze Fluid (cooling fluid)

Long effective frostbite antirust fluid of DF series is recommended and its ice point must be 8 °C lower than the lowest local temperature. The engine fluid from different factory can not be mixed to use.

Capacity Data

Parts		Capacity (L)
Fuel tank		106
Engine lubrication system		9
Engine cooling system		14.5
Gearbox		4.2
Rear axle	Add until to the inspection hole.	
Clutch system	Add to the MAX of the oil reservoir.	
Power steering gear	Add to between the MAX and MIN of the oil level stick	

Tightening Torque

Engine

Tightening parts	Tightening torque (N.m)
Fix bolt for fan	24
Fix bolt for water pump	24
Fix bolt (upper) for alternator	43
Fix bolt (lower) for alternator	24
Fix bolt for oil pump	24
Fitting for oil tube and filter	32
Fix bolt for fuel injector	55
Fix bolt for injection pump	24
Lock nut for injection pump timing gear	81
Connecting bolt for exhaust manifold and cylinder	43
Fix nut for pressure limiting valve	40
Oil drain plug	41
Fix bolt for crankshaft	137
Fix bolt for flywheel and crankshaft	137
Fix bolt for starter	43
Lock nut for valve adjusting bolt	24
Fix bolt for valve-chamber cover fixing bolt	24
Fix bolt for main bearing cover of crankshaft	176
Connecting bolt connecting-rod bearing cap	100
Fix bolt for flywheel housing bolt	77
Cylinder head bolt	126

Tightening Torque

Note:

No locking spacer, but to make sure the required tightening torque.

When tightening during installing, make use of the oil to lubricate. Do not use the bolt with thread damaged.

Each bolt need to tighten within 2~3 times.

Chassis

Tightening parts		Tightening torque (N.m)
Oil drain plug		130~150
Main drive gear big nut		350~500
Steering drag link nut		120~140
Left and right steering knuckle arm nut		120~140
Brake bottom plate bolt	Front bottom plate	140~170
	Rear bottom plate	156~206
Bolt of air chamber bracket	Front brake air chamber	55~70
	Rear brake air chamber	55~70
Bolt for air chamber	Front brake air chamber	55~70
	Rear brake air chamber	50~75
Engaged wheel bolt		140~160
Differential housing bolt		140~160
Half-axle nut		70~95
Locking pin nut		55~70
Steering limit bolt locking nut		80~100
Steering ball pin nut		130~160
Tie rod thimble nut		40~60
Adjusting nut	Front adjusting nut	120~150
	Rear adjusting nut	150~180
Knuckle pin plug screw		40~60

Chassis

Tightening parts	Tightening torque (N.m)
Front leaf spring U-bolts and nuts	250~300
Rear leaf spring U-bolts and nuts	300~350
Steering knuckle arm tightening bolts and nuts	200~250
Front wheel hub bearing adjusting nuts	120~150
Rear wheel hub bearing adjusting nuts	150~180
Tie rod ball pin nuts	192~226
Wheel bolts and nuts	280~350
Main reductor housing fix bolts	140~170
Connecting bolt for axle housing rear cover and axle housing	90~120

Attached Drawing:

Electric System Drawings

1. Battery
2. Fusible wire
3. Fusible wire
4. Power switch
5. Electronic main power switch
6. Starter
7. Starter relay
8. Ignition switch
9. Ignition relay
10. Electric control engine cut-off
11. Fuel cut-off electronic valve
12. Clutch switch
13. Exhaust brake electronic valve
14. Throttle switch
15. Exhaust brake switch
16. Exhaust brake indicator
17. Neutral switch
18. Assist starting button
19. Alternator
20. Fuse
21. Wiper motor
22. Wiper switch
23. Washer motor
24. Wiper intermittent relay
25. Fuse
26. Cigar lighter
27. Speaker
28. Fuse
29. Radio cassette
30. Speaker
31. Fuse
32. Heater relay
33. Heater motor
34. Heater motor resistance
35. Heater switch
36. A/C switch
37. Temperature control AMP
38. A/C relay
39. Dual direction pressure switch
40. A/C compressor
41. Heat emission relay
42. Heat emission motor
43. Fuse
44. Dome lamp and Switch
45. Left door switch
46. Right door switch
47. Horn button
48. Fuse
49. Horn relay
50. Electric control dual tone air horn
51. Electric horn
52. Electric horn
53. Air/electric horn shift switch
54. Fuse
55. Reverse gear switch
56. Left reverse lamp
57. Right reverse lamp
58. Reverse buzzer
59. Drier switch
60. Drier
61. Charging indicator
62. Oil pressure warning sensor
63. Oil pressure warning indicator
64. Oil pressure gauge

Attached drawing

65. Oil pressure sensor
66. Air flow blocked warning indicator
67. Air flow blocked warning sensor
68. Brake warning indicator
69. Air pressure too low warning sensor
70. Air pressure too low warning sensor
71. Air pressure too low warning sensor
72. Air pressure too low warning sensor
73. Parking brake indicator
74. Parking air pressure switch
75. Fuel gauge
76. Fuel sensor
77. Water temperature gauge
78. Water temperature sensor
79. Water temperature warning indicator
80. Tachometer
81. Revolution sensor
82. Combination switch--lighting part
83. Low beam
84. High beam
85. Left headlamp
86. Low beam
87. High beam
88. Right headlamp
89. High beam indicator
90. Left front lamp
91. Right front lamp
92. Front clearance lamp
93. Front clearance lamp
94. Rear clearane lamp
95. Left side position lamp
96. Fuse
97. Fuse
98. Fuse
99. Rear clearance lamp
100. Right side position lamp
101. Licence lamp
102. A/C control panel indicator
103. Speedometer illuminator
104. Instrumrnt illuminator
105. Air pressure gauge illuminator
106. Left front fog lamp
107. Right front fog lamp
108. Brake lamp switch
109. Combination warning controller
110. Left rear lamp
111. Right rear lamp
112. Left brake lamp
113. Right brake lamp
114. Left rear fog lamp
115. Right rear fog lamp
116. Safety belt indicator
117. Filament check warning indicator
118. Buzzer
119. Door lamp switch
120. Rear fog lamp indicator
121. Rear fog lamp switch
122. Fuse
123. Quartz clock
124. Hazard warning switch
125. Fuse
126. Flasher
127. Combination switch-steering part
128. Left turning lamp
129. Left turning indicator

- 130. Front
- 131. Rear
- 132. Right turning lamp
- 133. Rear
- 134. Front
- 135. Right turning indicator

